

Varenummer: 204380M24200D3U

Beskrivelse: E+G Justerfod
GN 43-80-M24-200-D3-U

Note: U Uden møtrik, sekskant i toppen, spændeflade i bunden

Mål

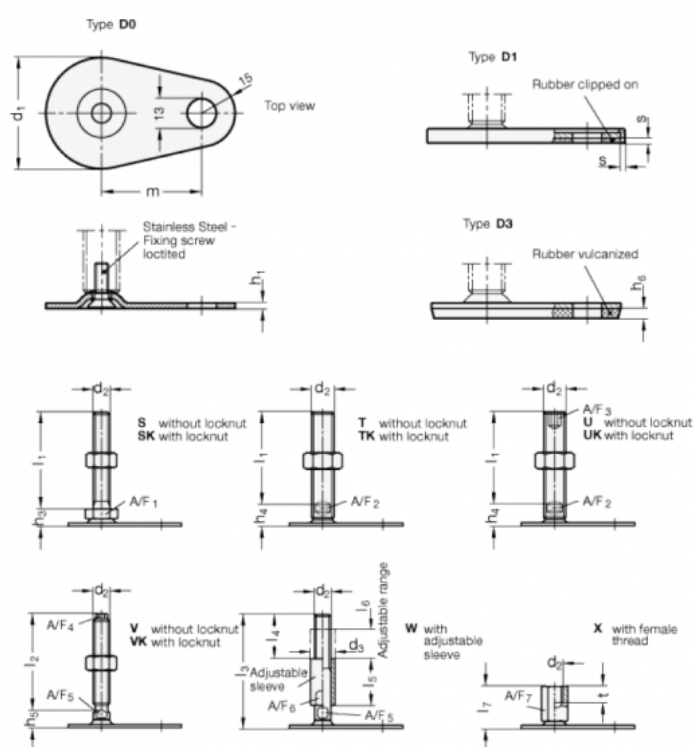

A/F2 = 19	m = 70
A/F3 = 12	s =
d1 = 80	
d2 = M24	
h1 = 3	
h4 = 21	
h6 = 5	
l1 = 200	